

1:100
X
1:50
Y

1:100
X
1:50
Y

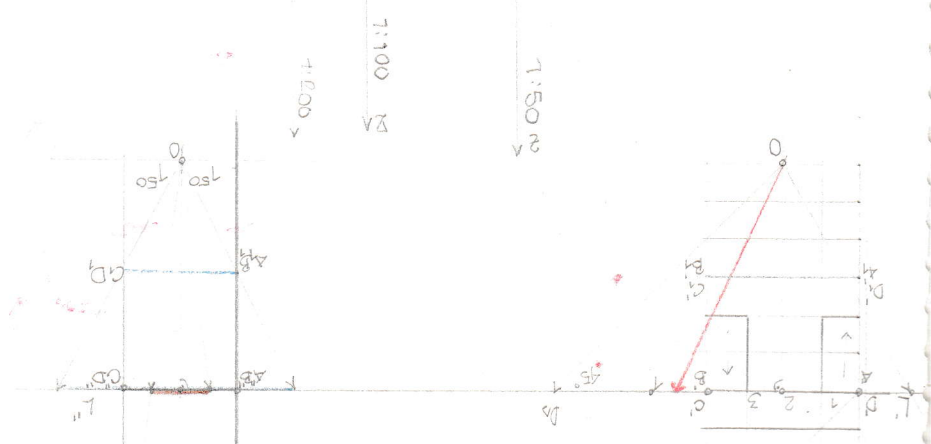
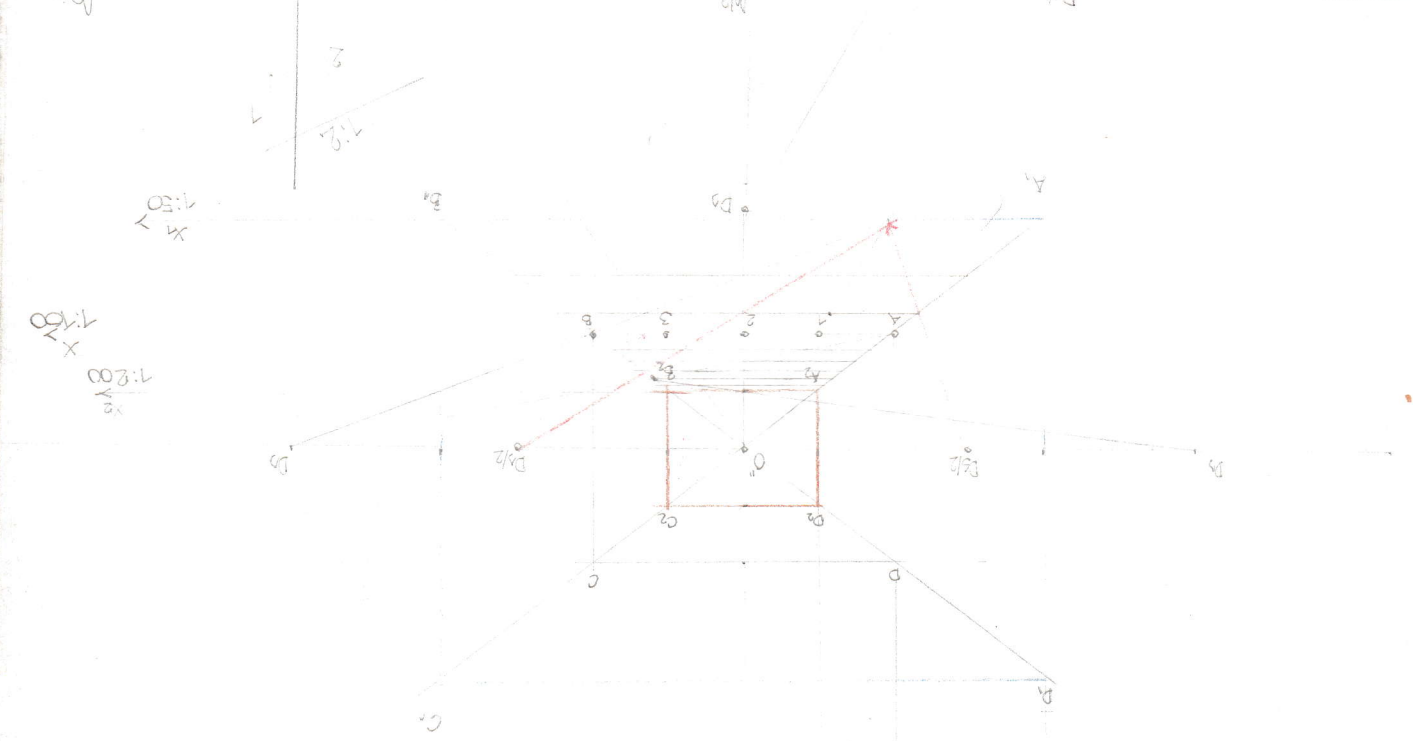
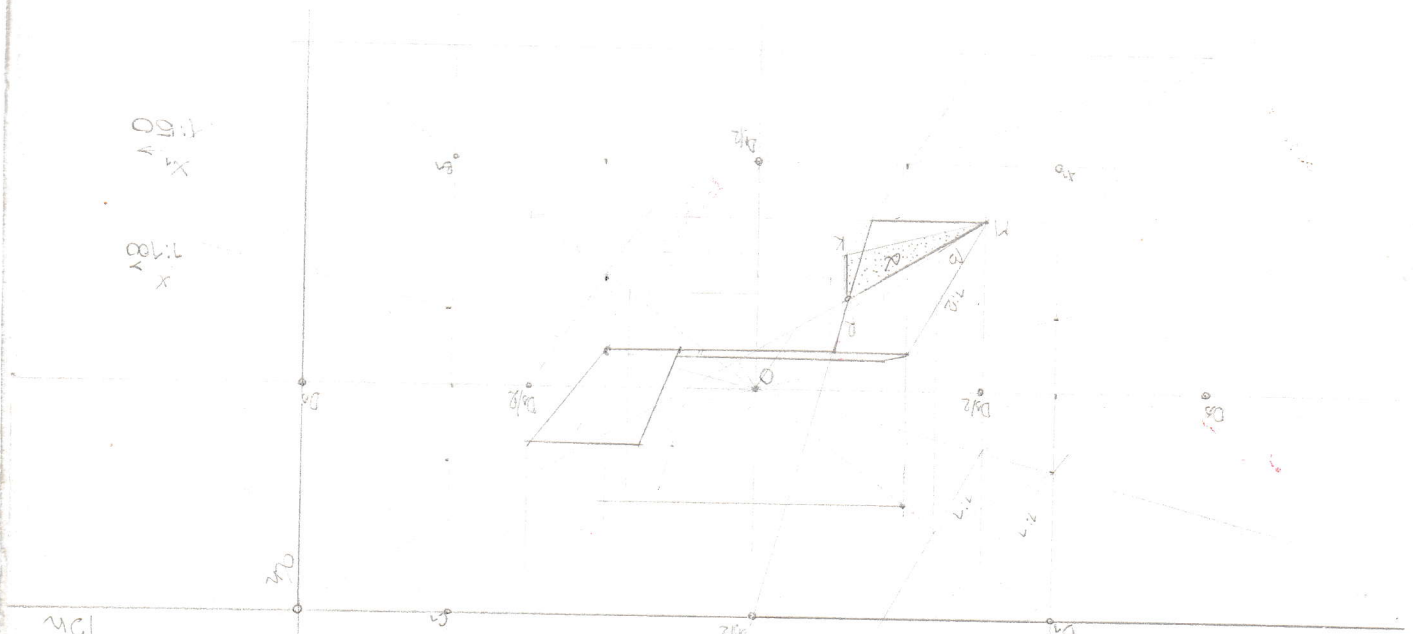

0014-22

$36^{\circ} 30'$
 $O \cdot r = 1.5m$

$30^{\circ} 30'$

1/1 dh

②

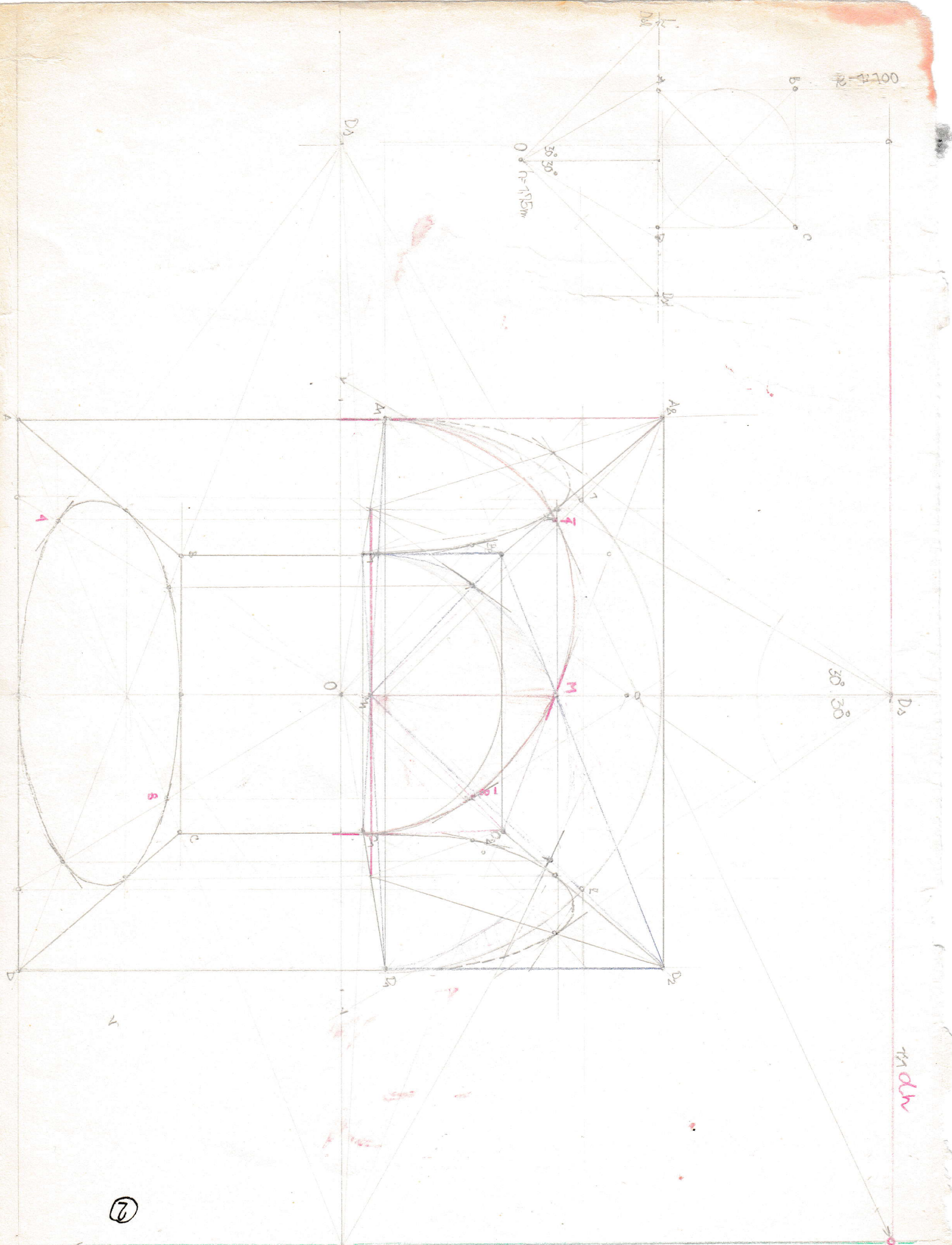

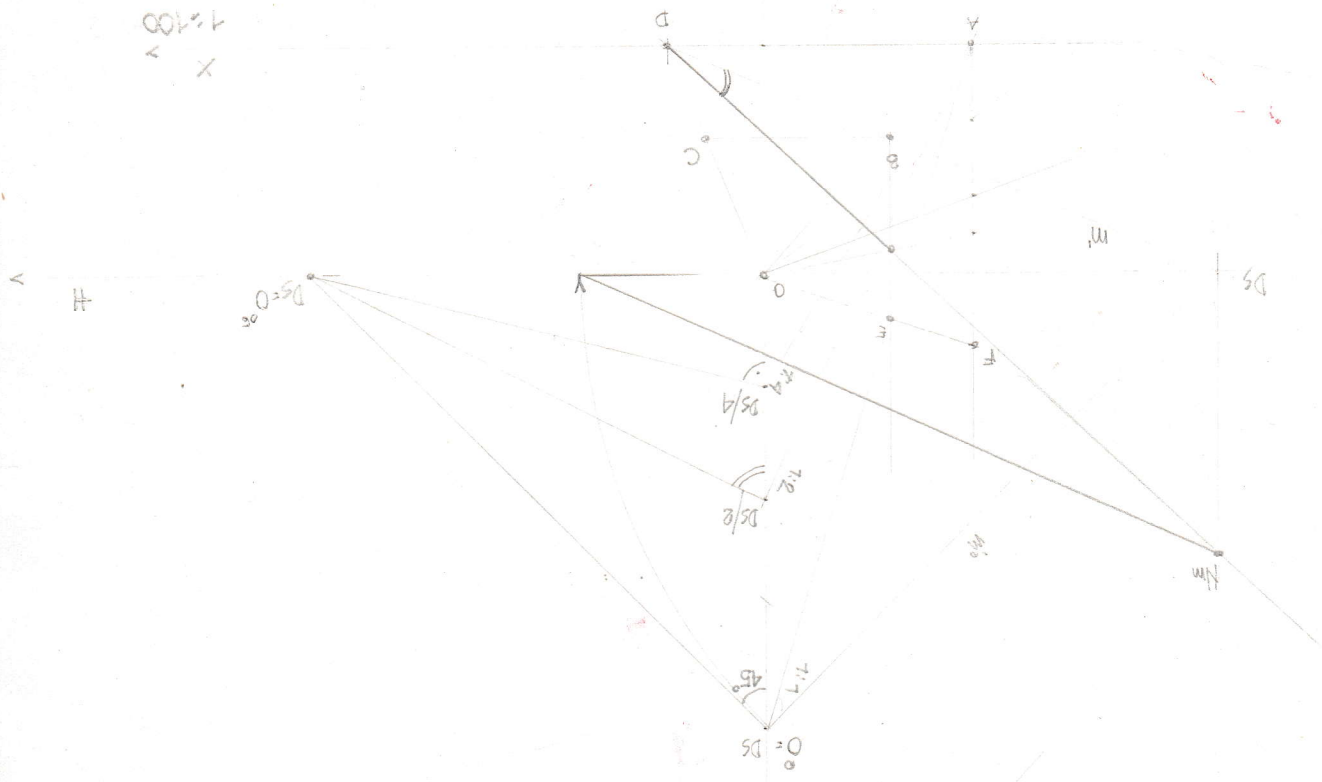

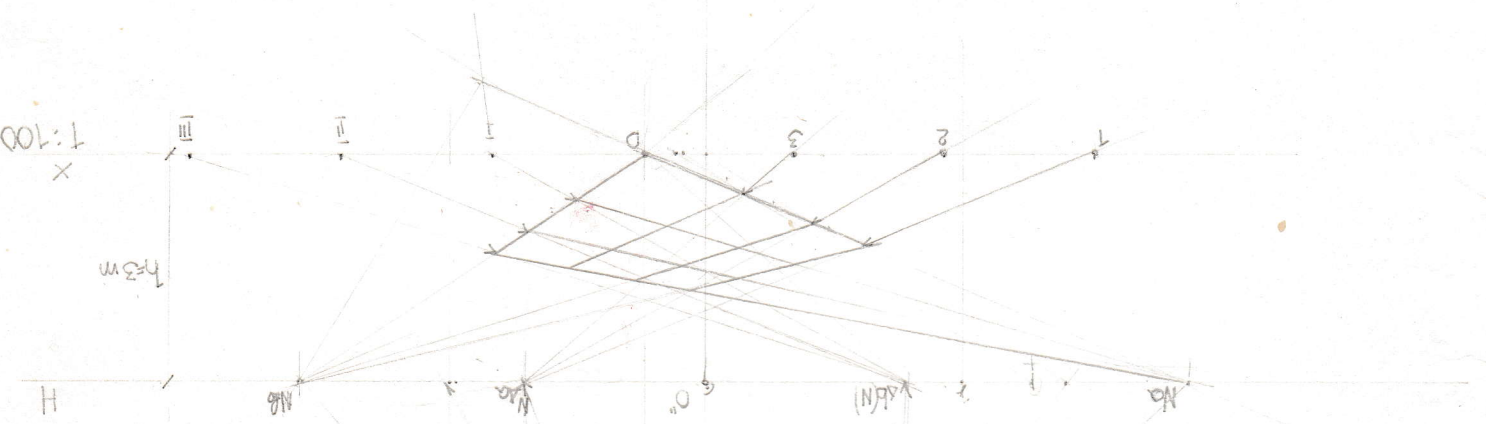

1:100
X

$h=3m$

H

M_b

M_a

0°

N_0

N_0

$0 [h=3m]$

$0.56m$

1.30

2.00

N_0

N_0

N_0

N_0

N_0

N_0

N_0

N_0

N_0

N_0

N_0

N_0

N_0

N_0

N_0

N_0

N_0

N_0

1250

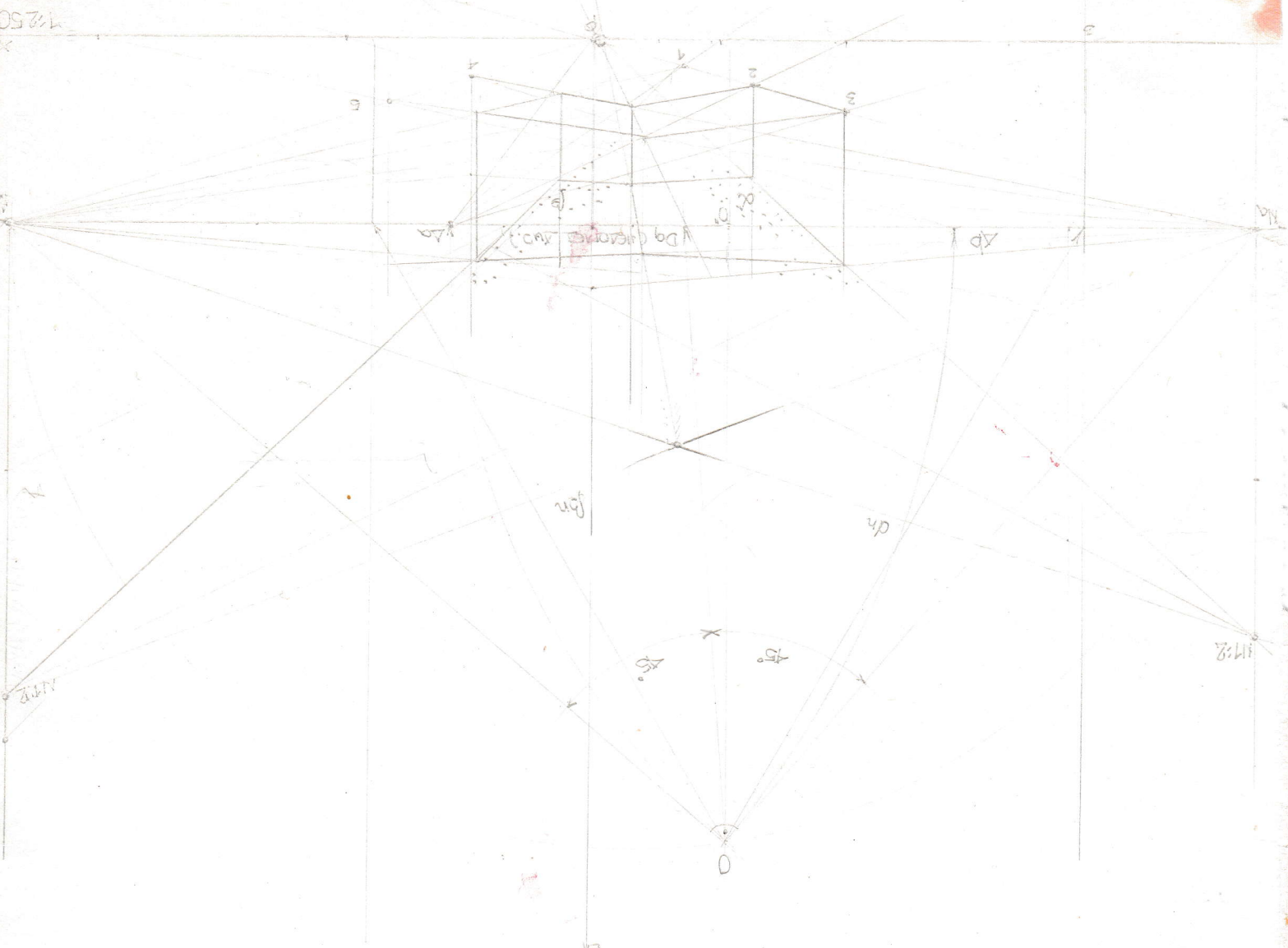

18

l = 15m

R = 1 : 1000

REKABANO DIVYA

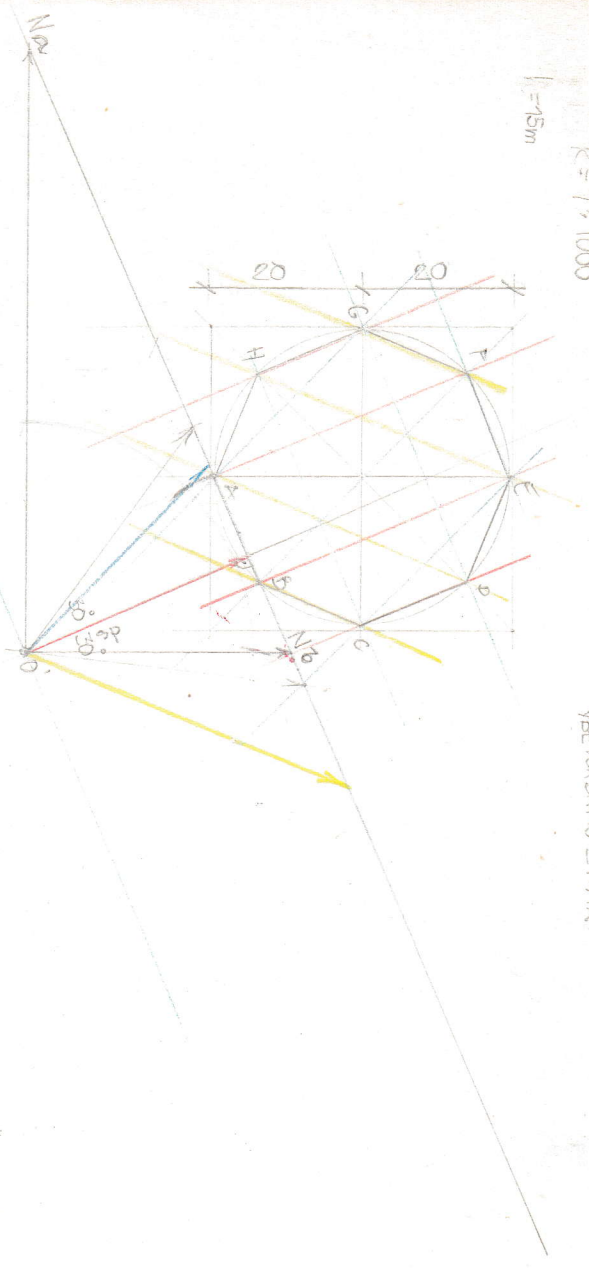

1250

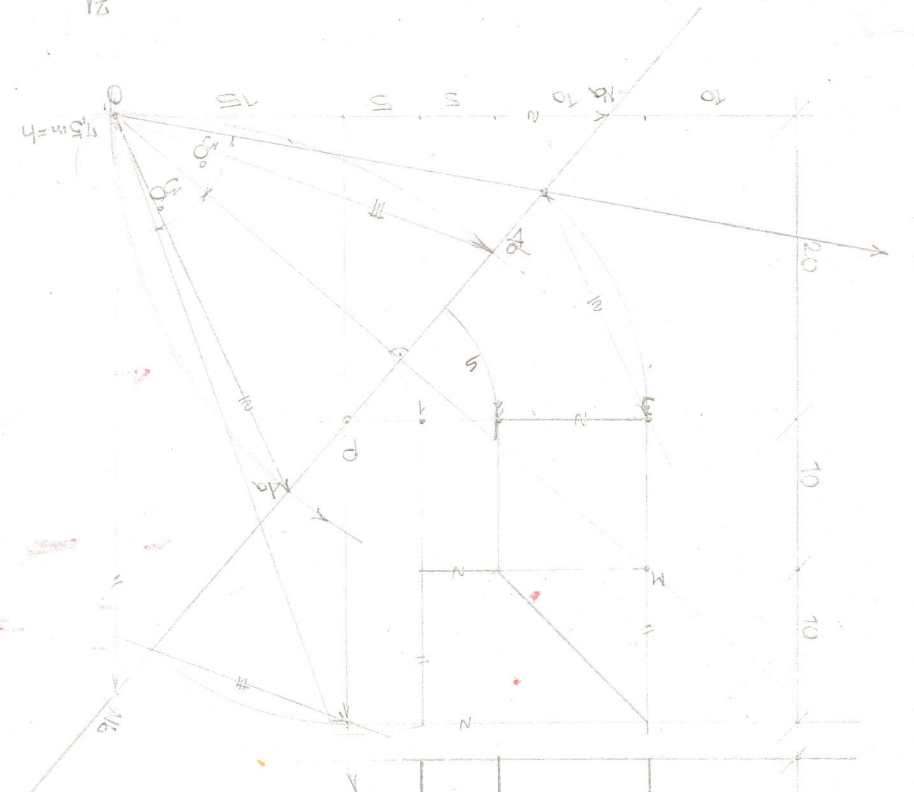
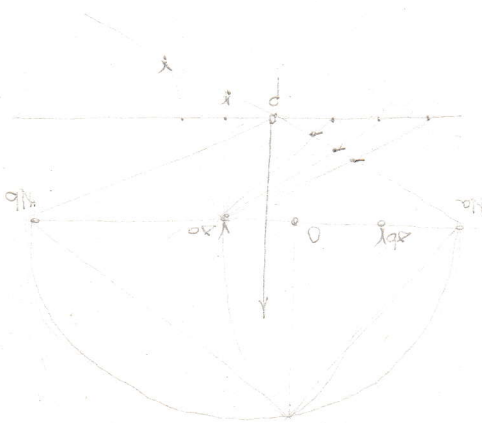
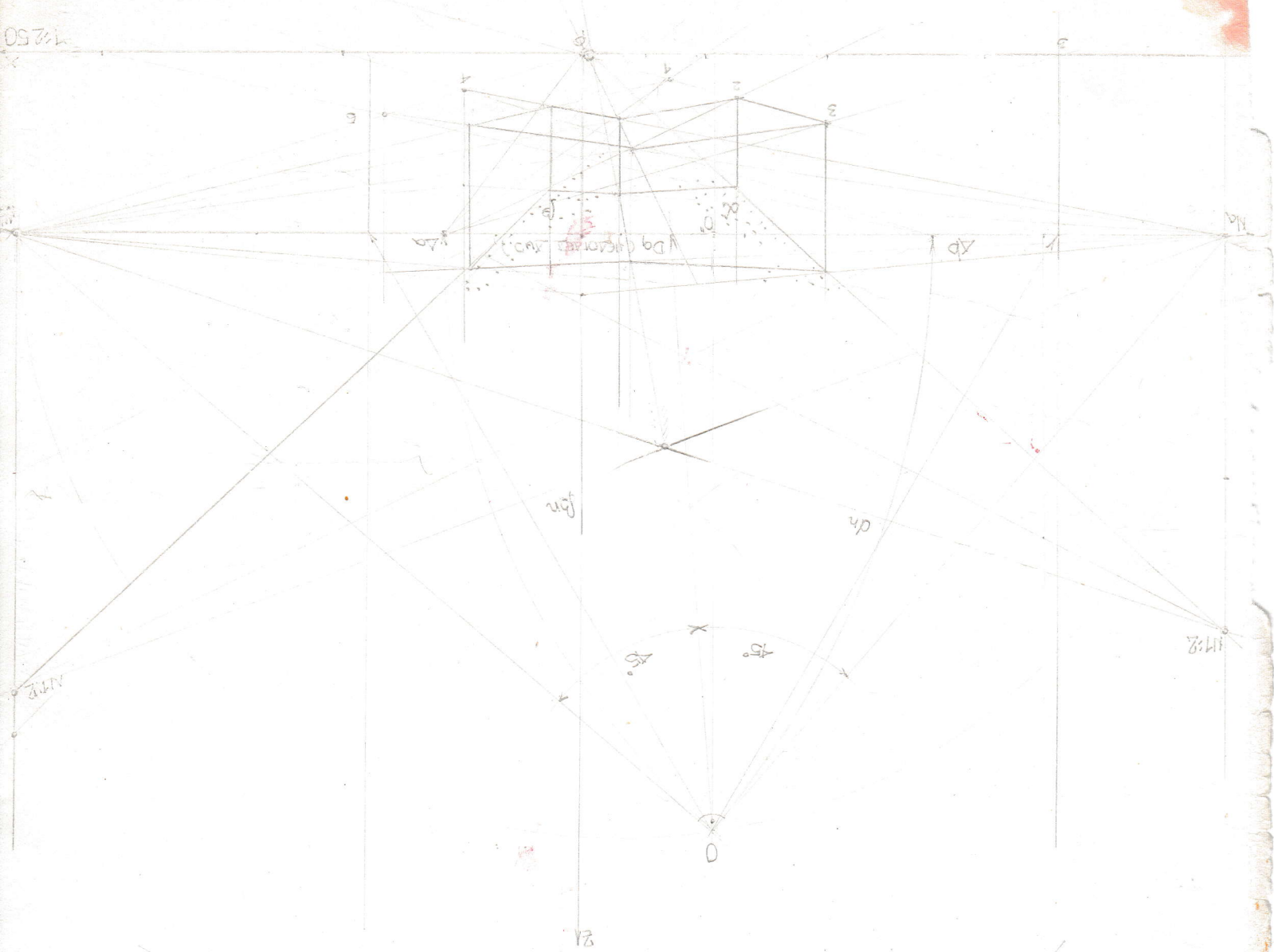

18

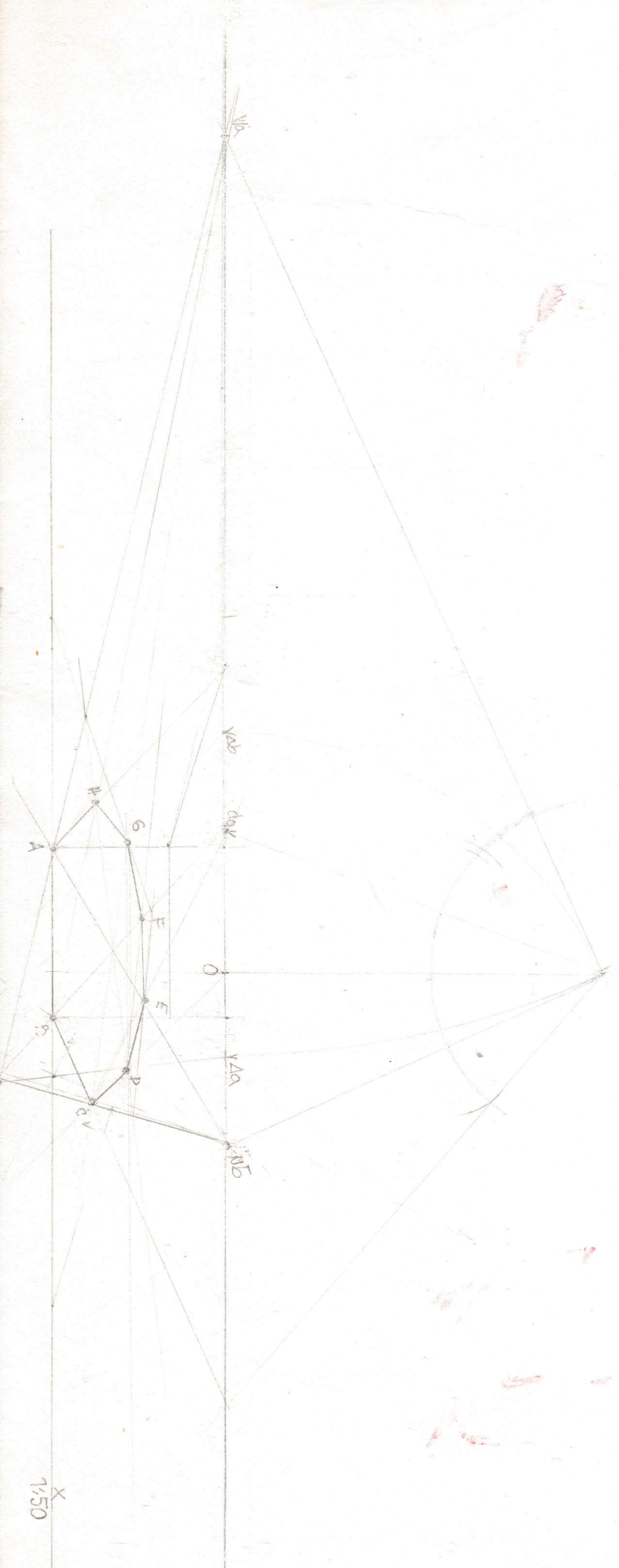

1/2
X

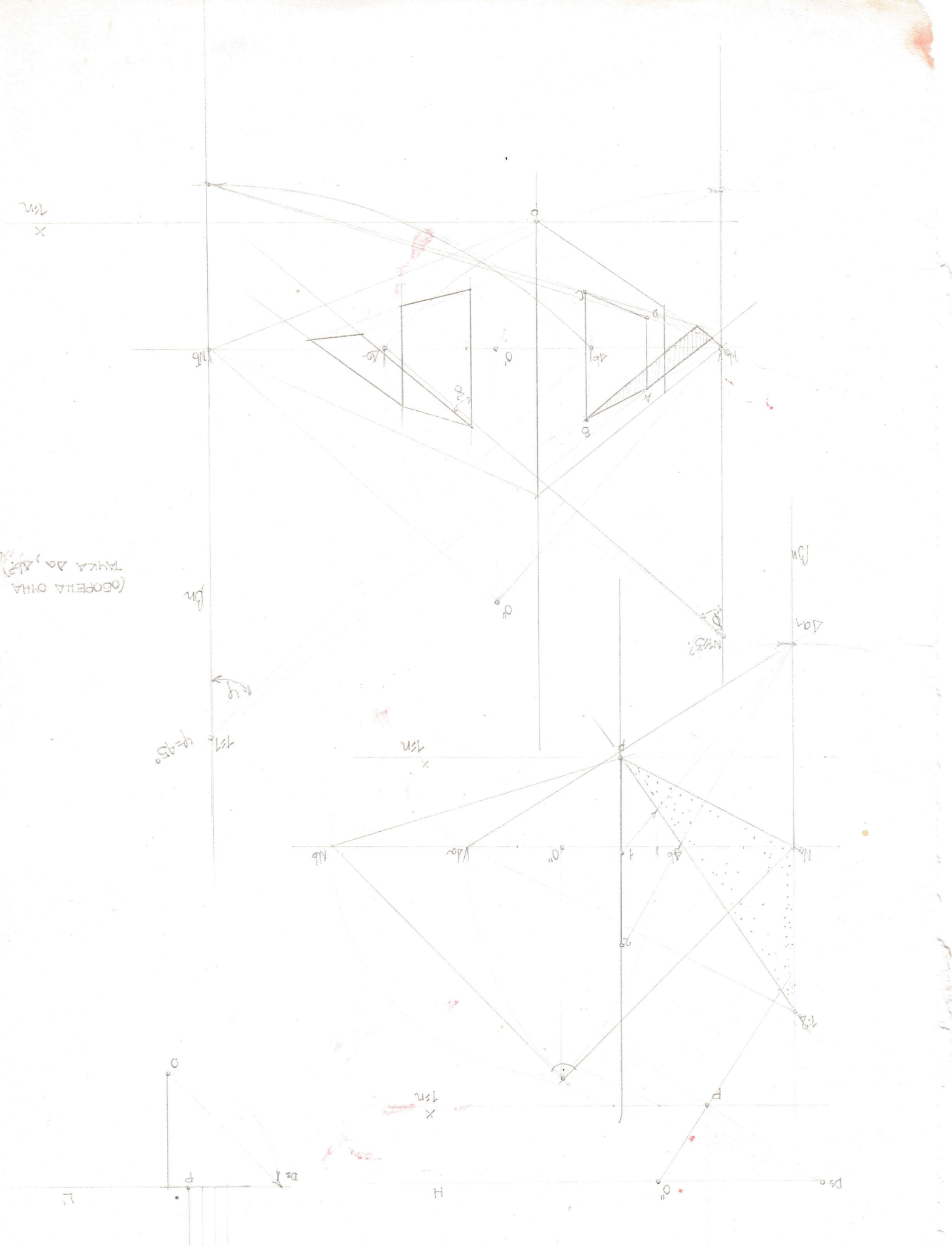

(GEOMETRIA DITTA
TARCA DO, 1872)

45°
 45°

X
1/2

L'

H

O''

Ds

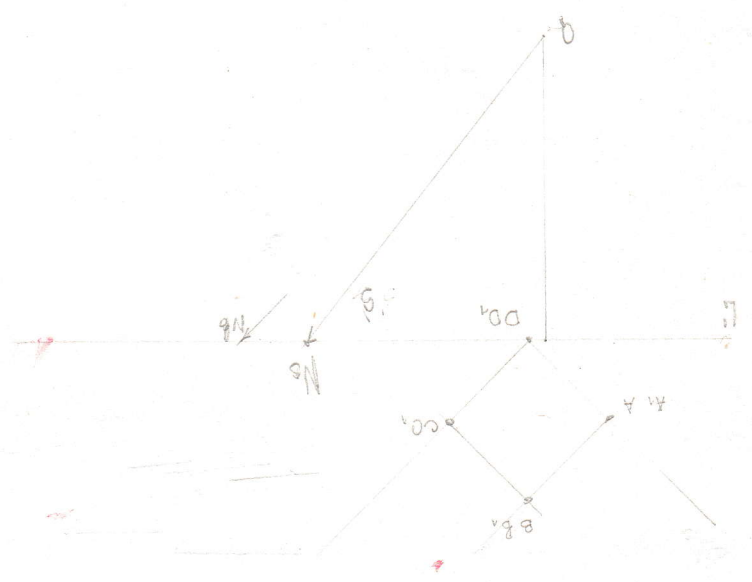
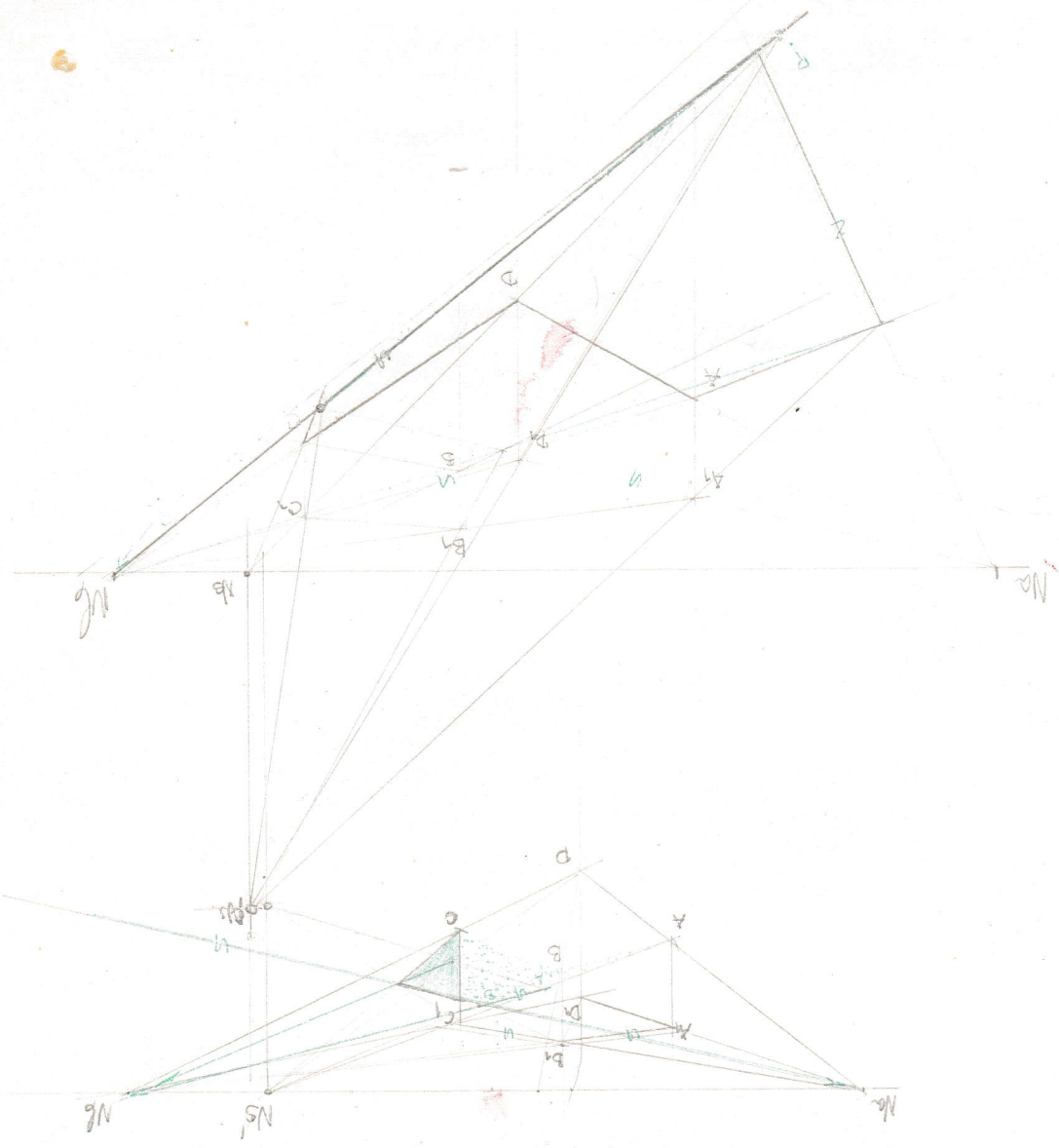

5

98

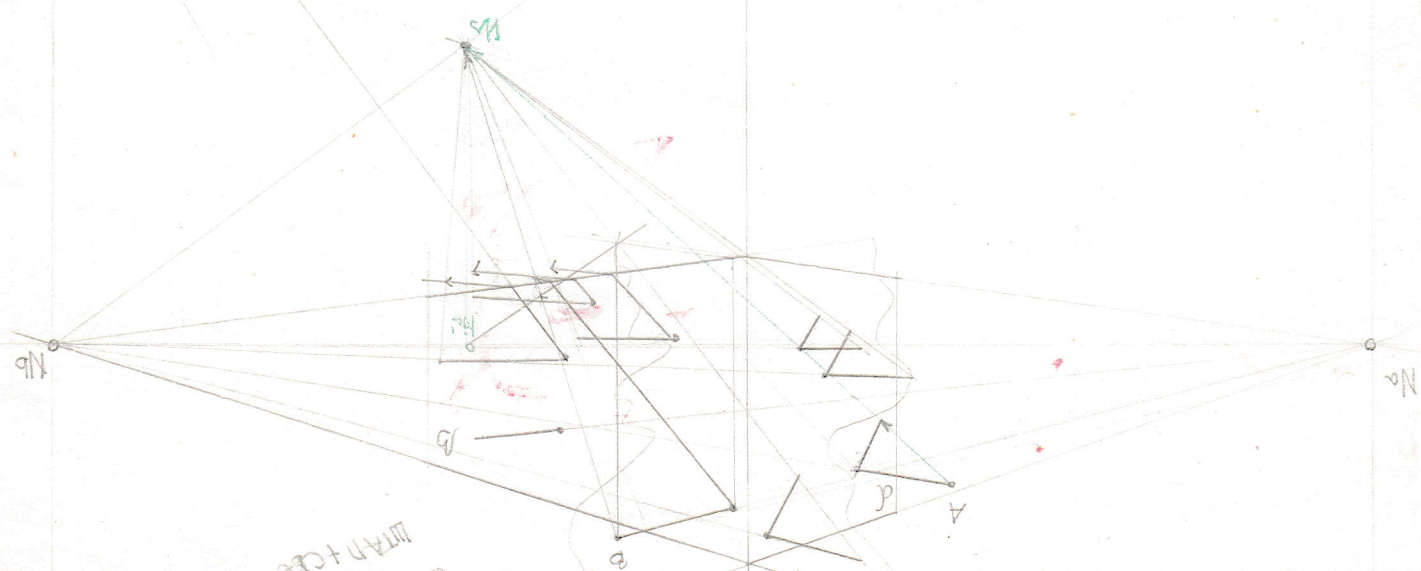

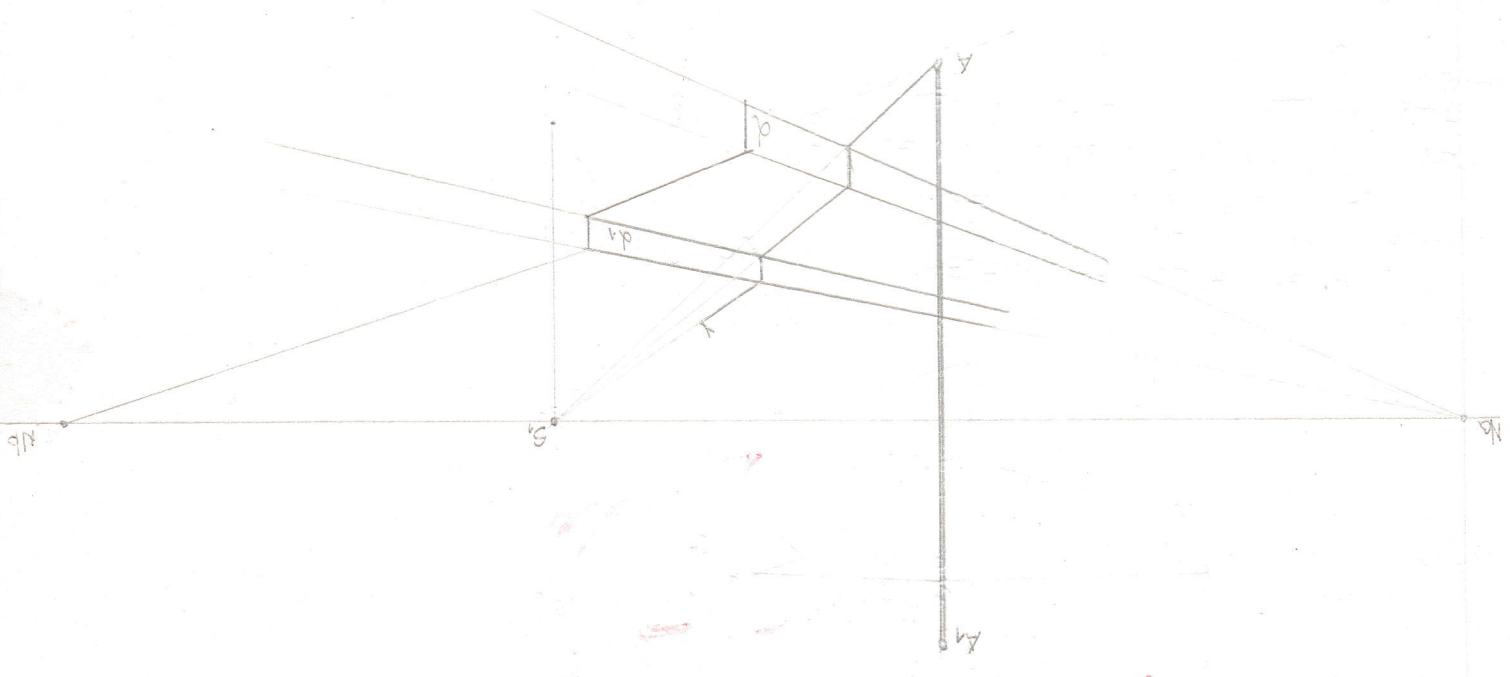
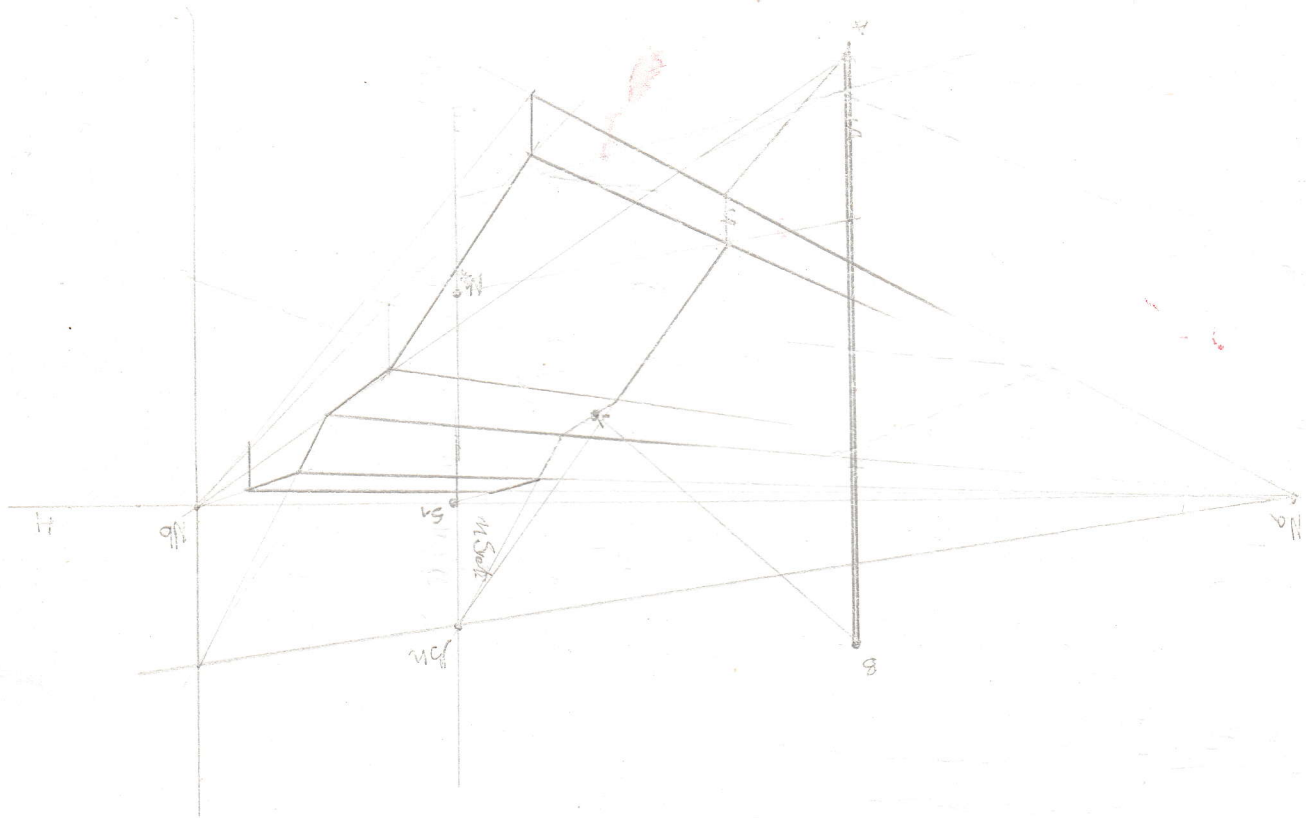

BA Лп

№ 50 - ПЕРЕКРЕСТНОЕ ПЕРЕСЕЧЕНИЕ
ЦЕНТРА ПРЯМОУГОЛЬНИКА
№ 50 А В
ПРОСЪ А 1

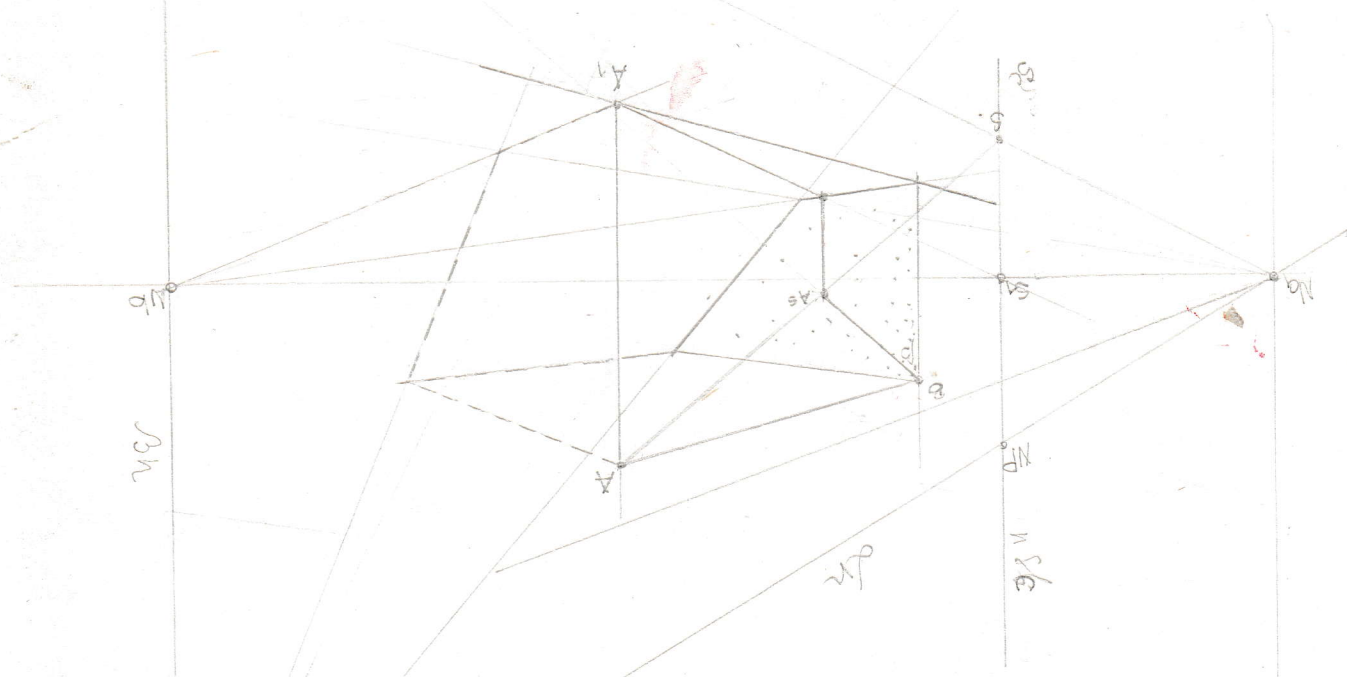

ПРЯМЫЕ А И А' - НЕОДНОЗНАЧНО
КОСОУШТАТА ПО КОМУЗОВАТА И
РАБОТА (U)
2) 1- ПРОДОЛЖЕНИЕ ЛИНИИ ВЪЗ
ВЕРХУ А И ПРАВАЯ ЧАСТ
УСЛОВИЯ ЧЕРТА
А 0 - - - - -

ПРЕКРЕСТНОЕ ПЕРЕСЕЧЕНИЕ
КОСОУШТАТА СЪ КОМУЗОВАТА И
ВЕРХУ А И ПРАВАЯ ЧАСТ
УСЛОВИЯ ЧЕРТА ТАКЕ А И
КОМУЗОВАТА

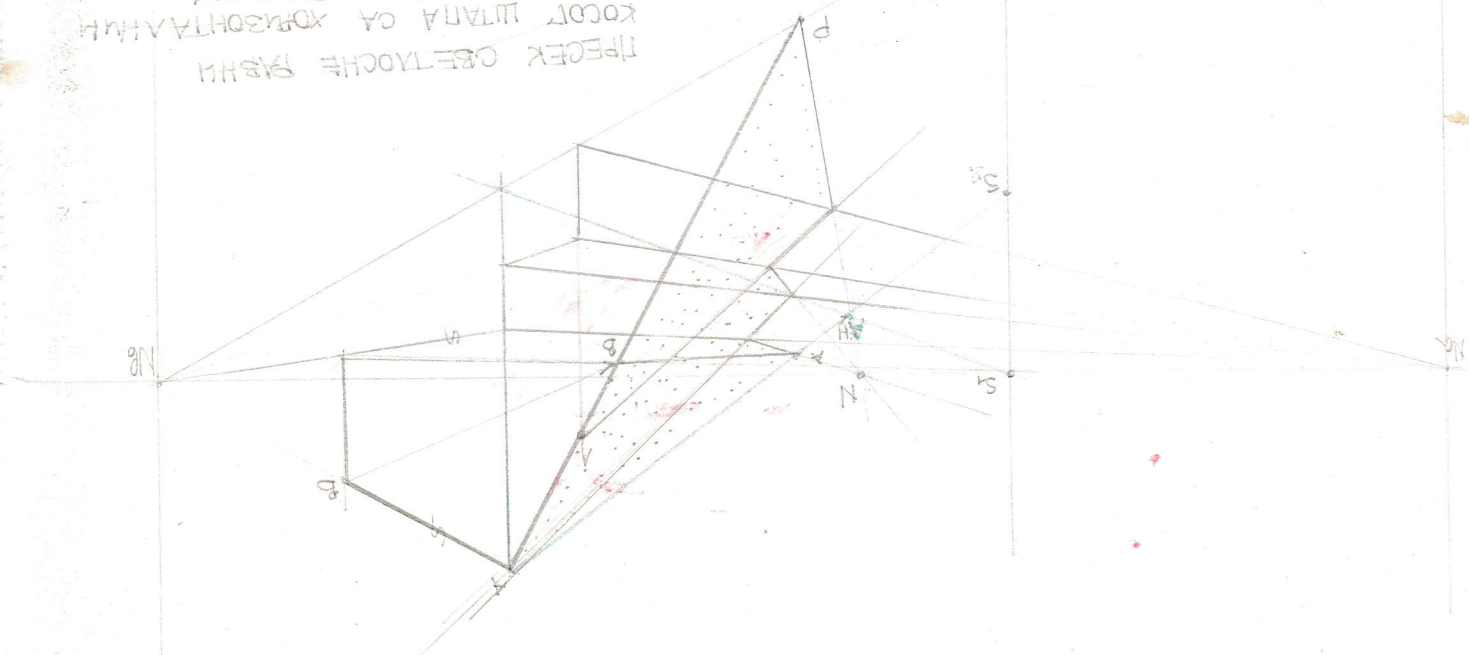

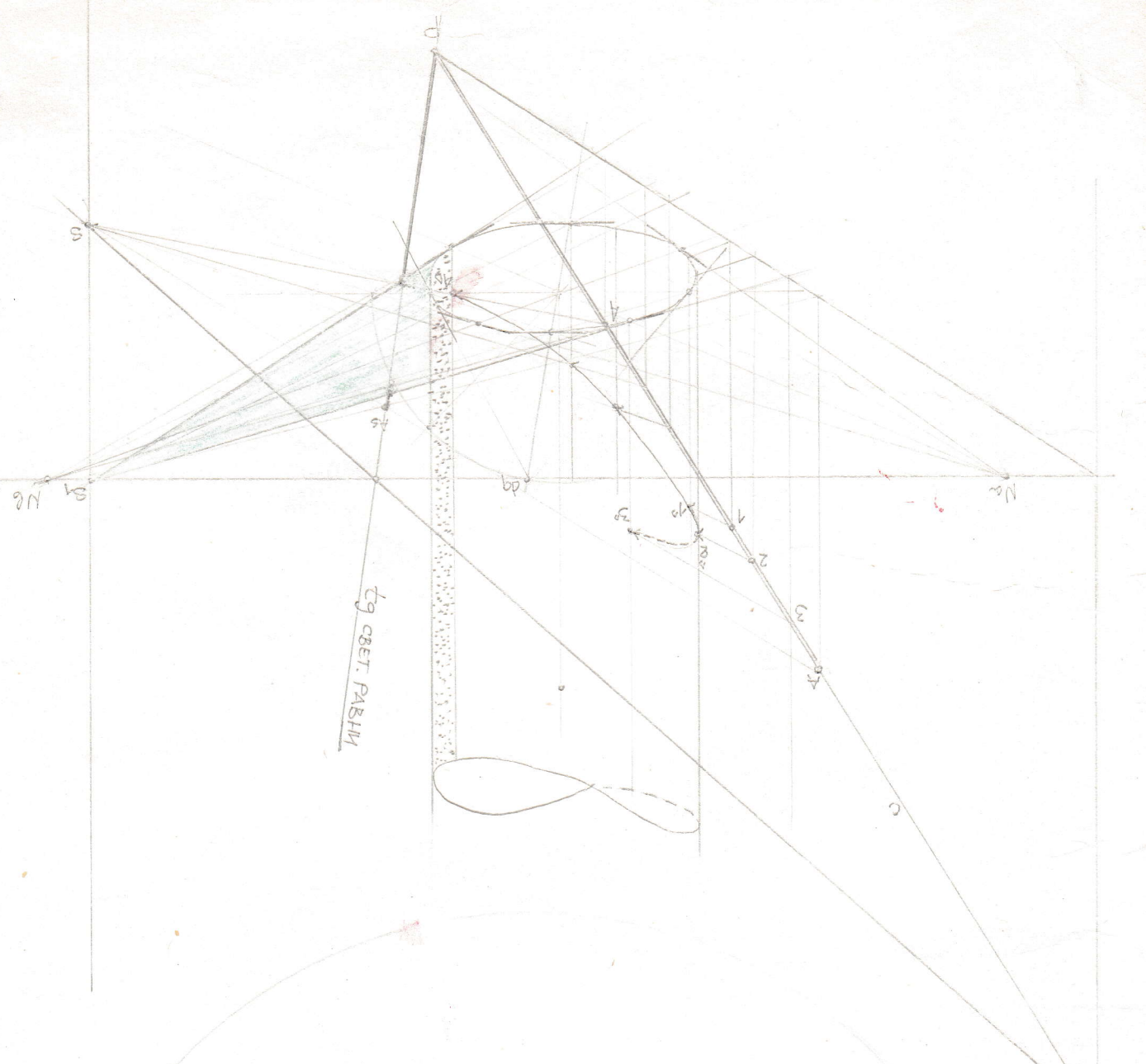

ЦГ СВЕТ. ПАВЛИН

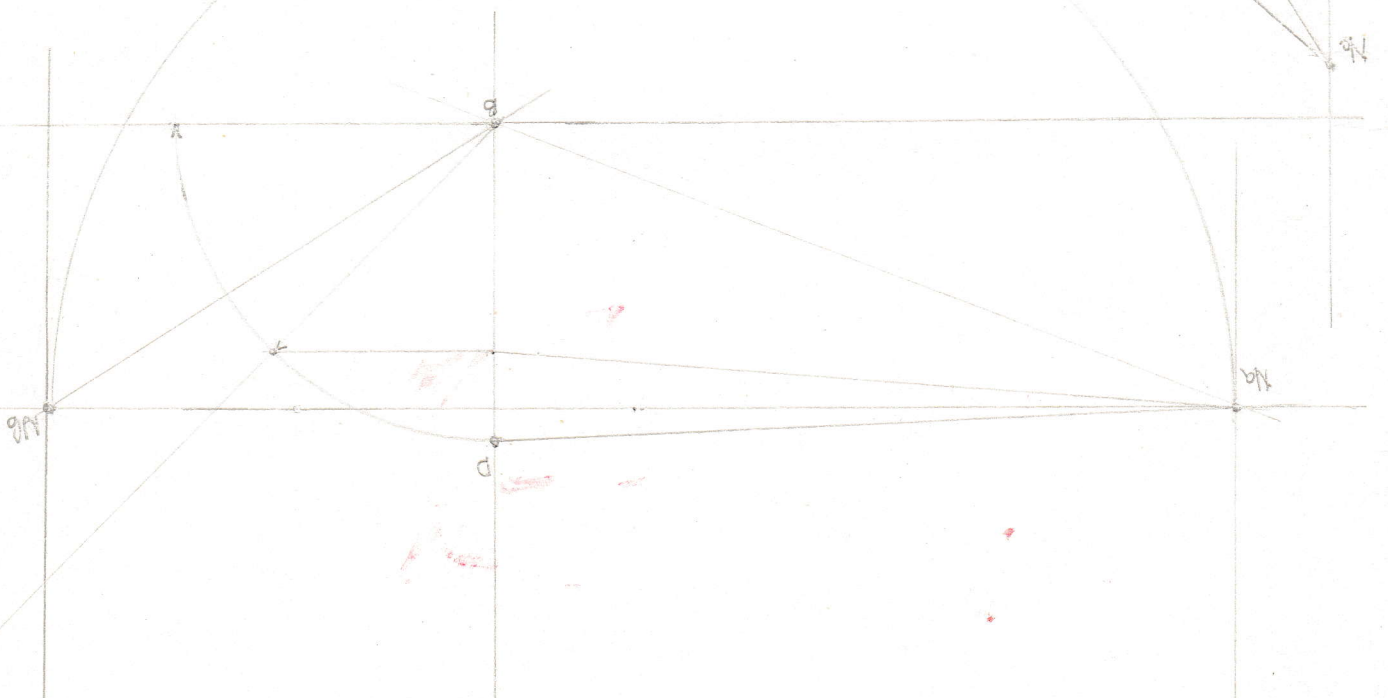



ПОЛОЖЕНІЯ СЪЕДИНЕНІЯ
 КРОСЪ ИСАТОКЪ АМЪ (D B)

Д.В. (1.8)

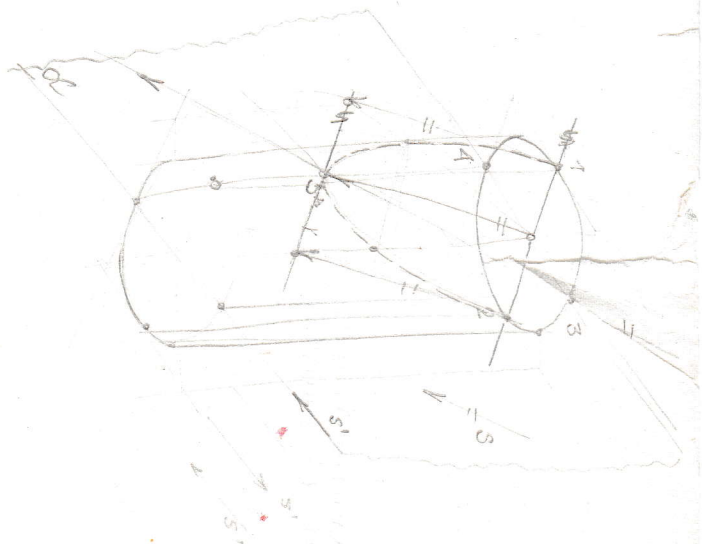

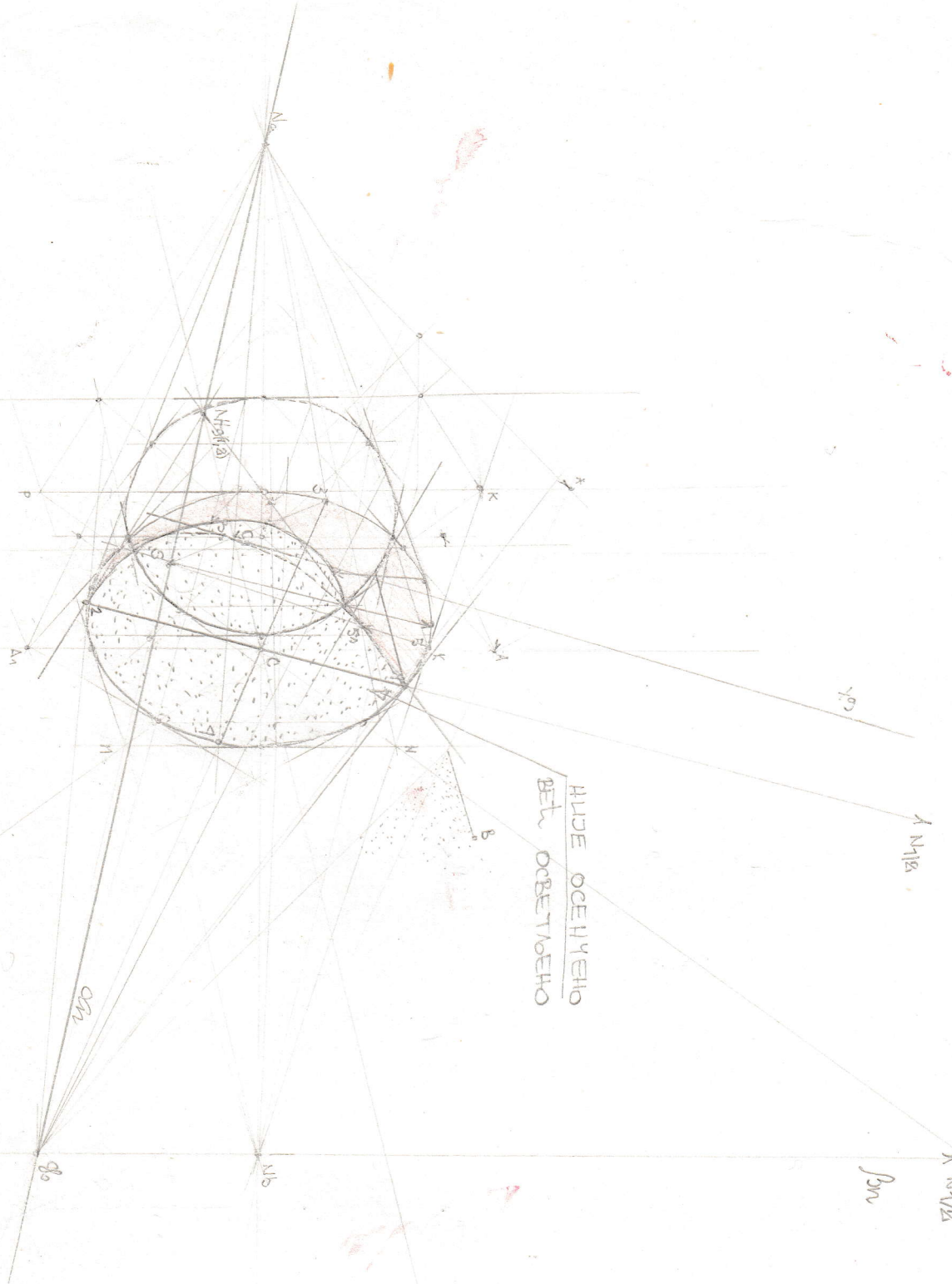

РУССКОЕ
 ОБЩЕСТВО

A N 1/2
 100

A N 1/2
 100

OM

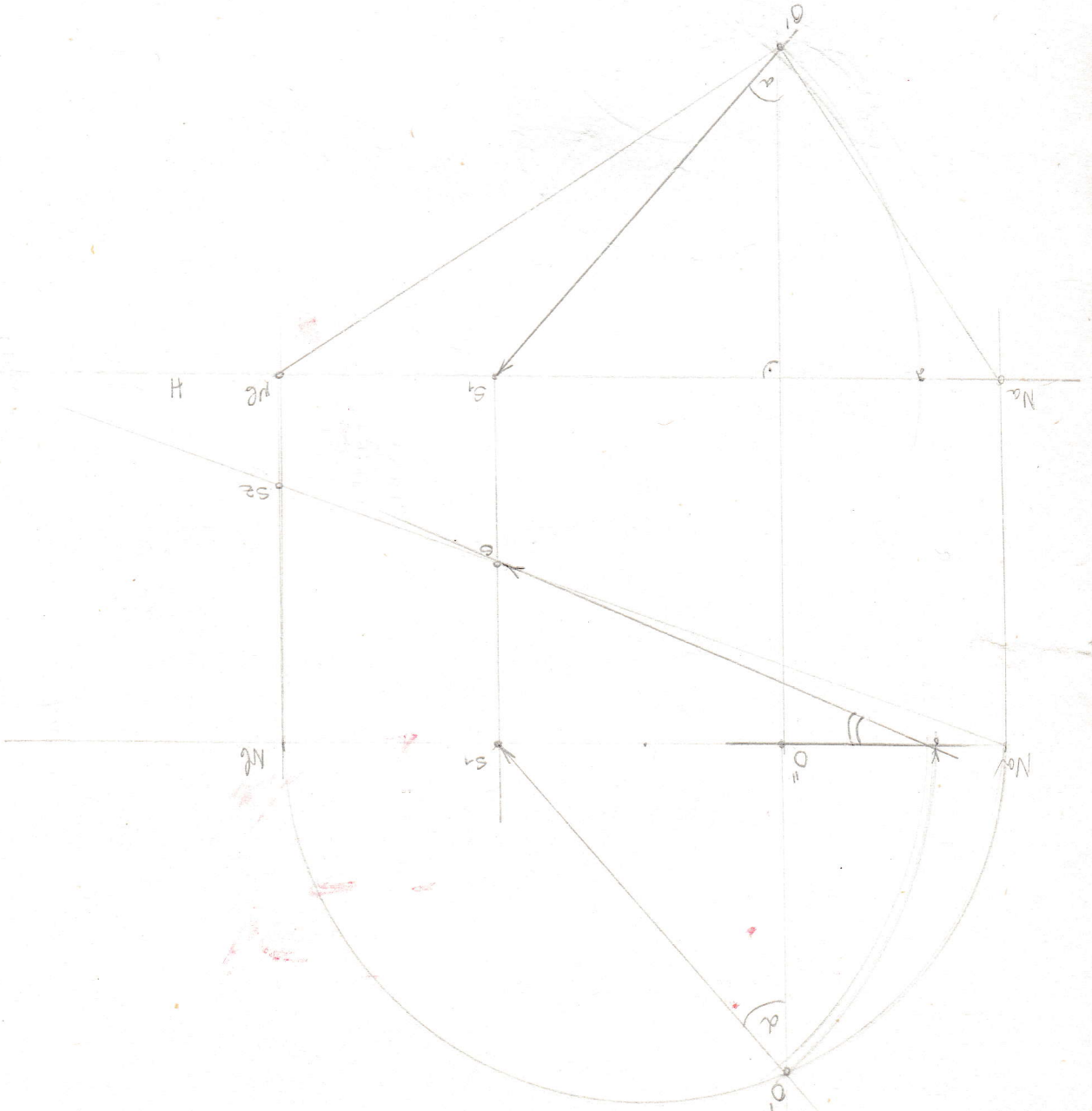

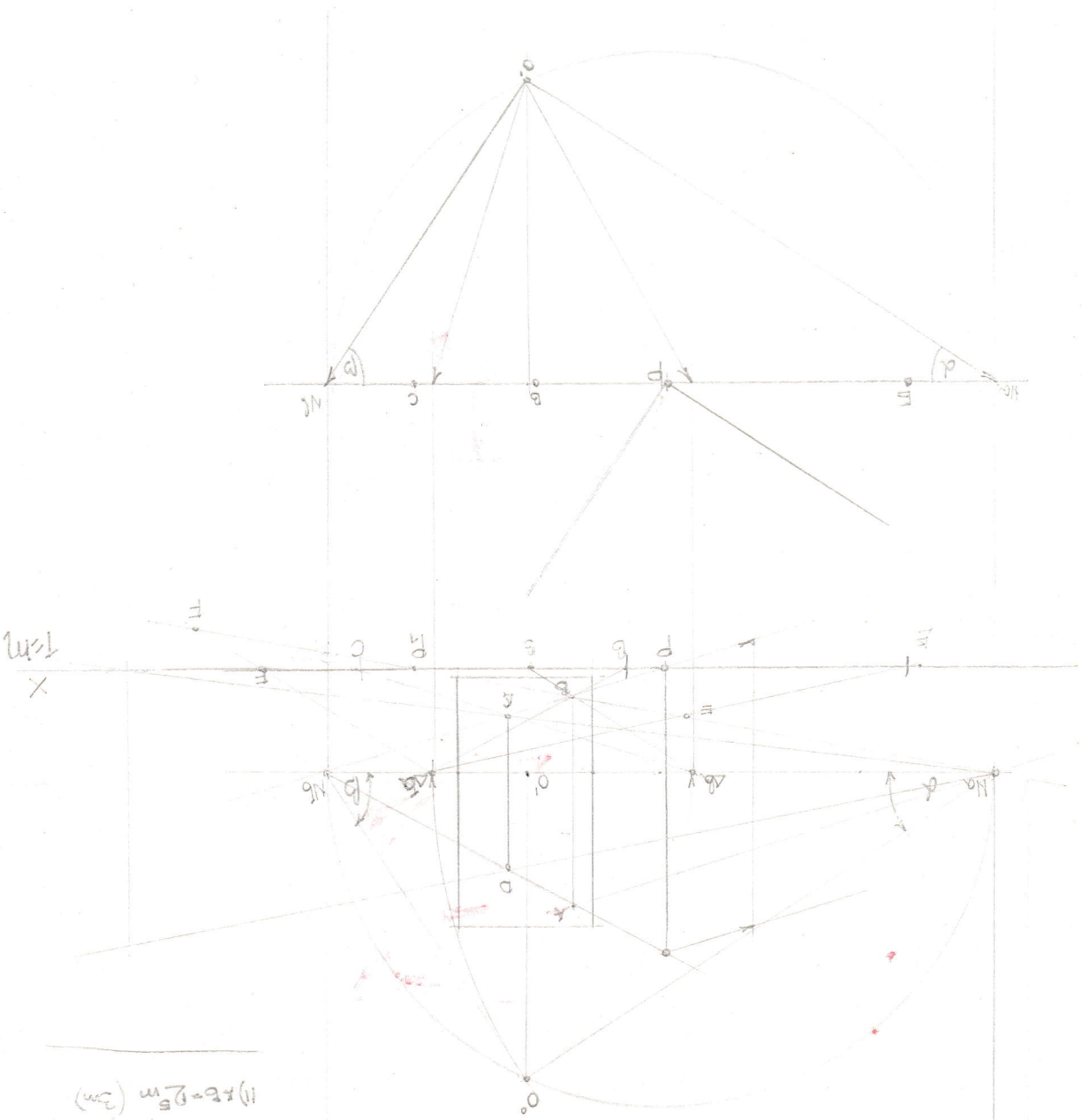

(2) $a = 2\text{m}$
 (3) $b = 2\text{m}$

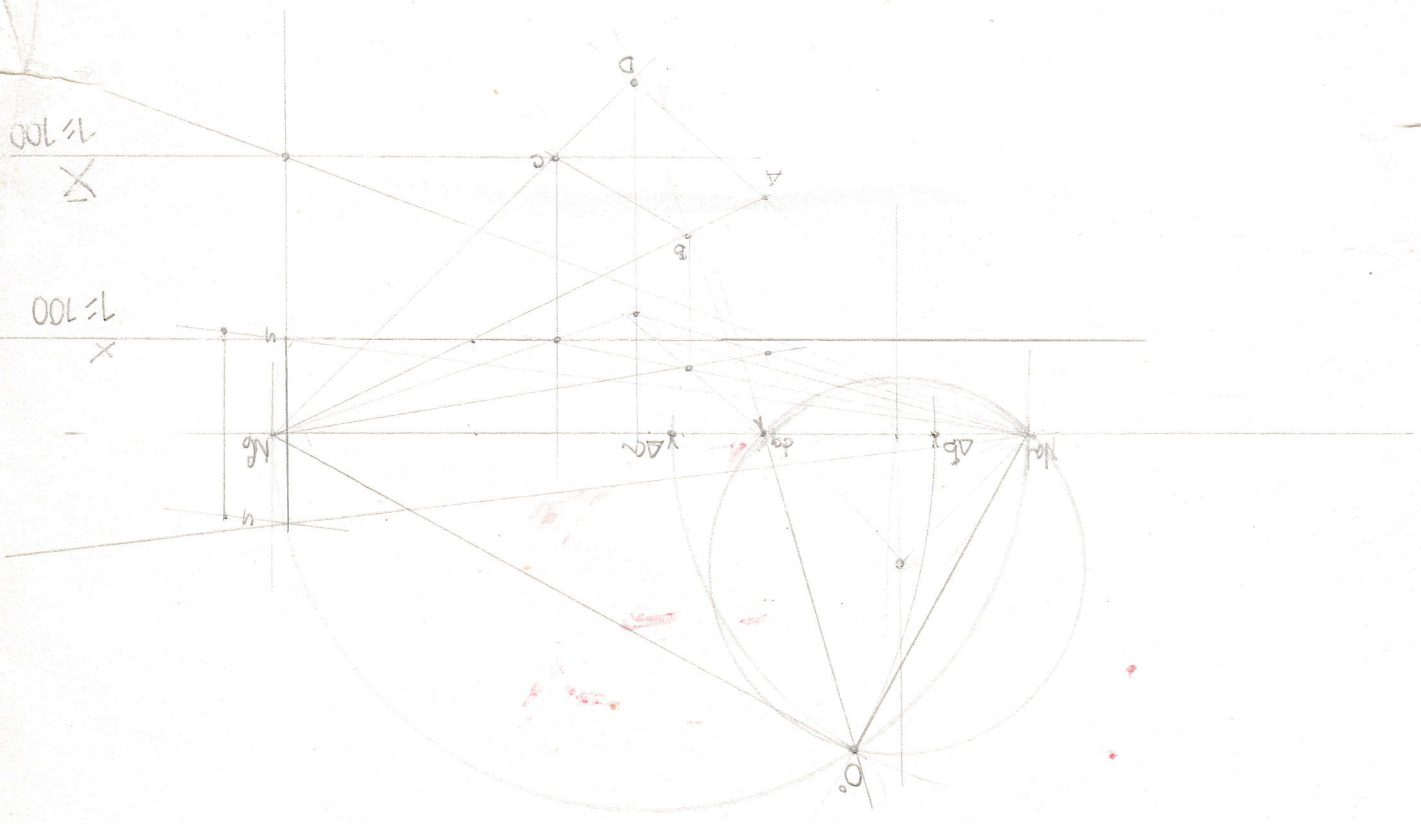

\times
 $1:100$

\times
 $1:100$